

Company Profile
**Trading &
Material**
////

“Inspiring
Confidence”



Company **Overview**

ABOUT US

We are pleased to introduce Al-Falah Trading & Material, a part of Al Falah in Al-Jubail which was established in 2006 with a view of providing various Professional Engineering Services. Over the years the Company has grown & diversified to become a renowned & a reliable provider of many Products & Services. With 8+ years of extensive experience in diesel engines, With its world class infrastructure, technical competency and controlled re-manufacturing process, company delivers high end products to its valuable customers.

Our Major Brands

Al-Falah Trading & Materiel deals with the supply of Genuine Parts like Pistons, Rings, Liners, Bearings, Valves, Gaskets, Pumps, Oil Seal S Thermostats. Genuine Parts is a UK based company & deals in the supply of Quality Replacement Diesel Engine Parts for Cummins, Caterpillar & Perkins. Today Genuine Parts is well recognized for providing quality parts, excellent service and on time delivery. Genuine Parts credits this success to its culture of Customer Satisfaction by exceeding the Customer Expectation, through continuous improvement and commitment to excellence, integrity, and teamwork.

Value Power



Powertech

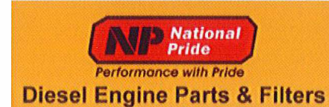

Tailift



APPLIANCES FOR PROJECT DIVISION AS A PROJECT DISTRIBUTOR



SMART TV 50"



SMART LED TV 43"



TOASTER 4 SLICE WITH GRILL PLATE



WATER DISPENSER WITH REFRIGERATOR

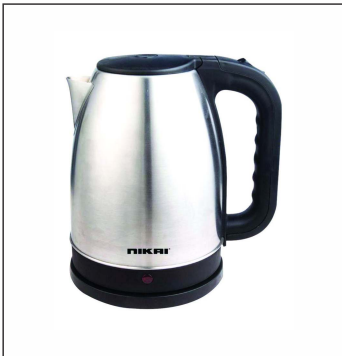

ELECTRIC KETTLE 1.7LTRS



MICROWAVE OVEN 23L



WATER DISPENSER TABLE TOP



BAR FRIDGE SILVER



REFRIGERATOR 91LS - BASIC



FROST REFRIGERATOR WHITE



COFFEE MAKER 1.5LTRS



195 Ltr Single Door Refrigerator



KATKO SWITCH



**COFFEE MAKER
1.5LTRS**



65" UHD SMART TV



**50" UHD
4K SMART TV**



**UHD 4K TV 55 inch
UP75 Series,**



65" UHD TV



**UHD 4K TV
55 inch**



Electrical Commercial & Industrial Materials



Electrical & Instrumentation

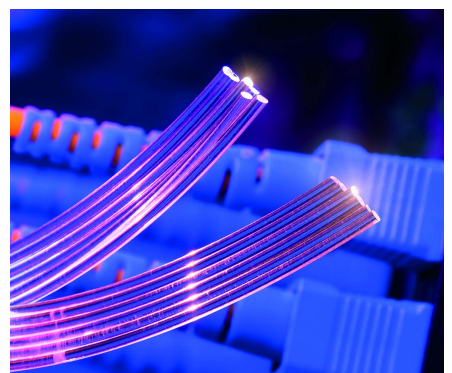
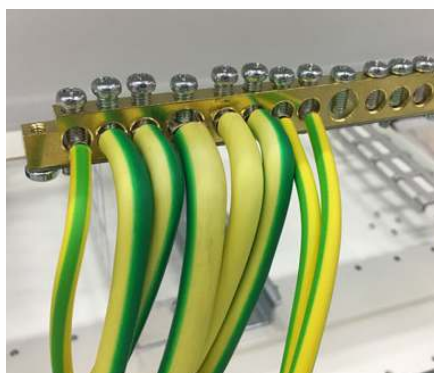
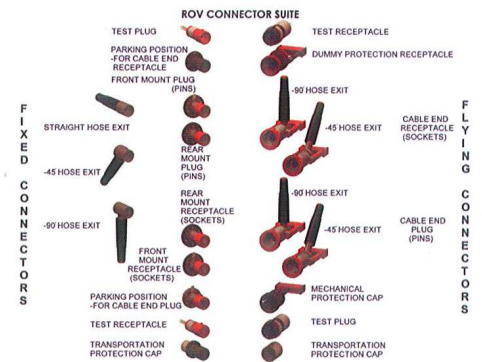

Electrical Pumps & Tools



Aerosols, Coatings Wire Pulling Lubricants & Adhesives

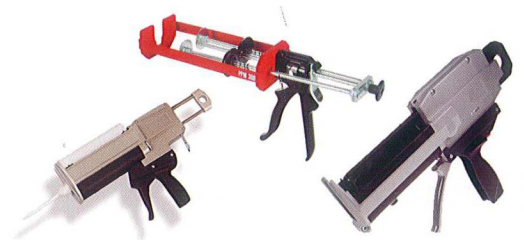
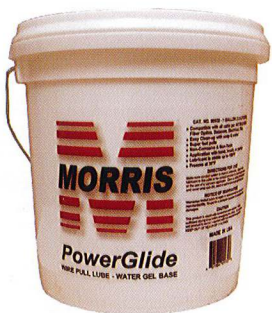

Scaffolding Items & Fittings



Mechanical & Civil Construction Materials

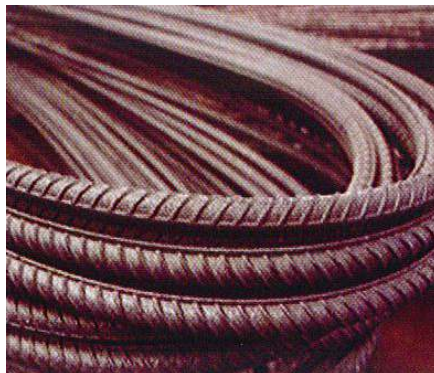

Safety Items

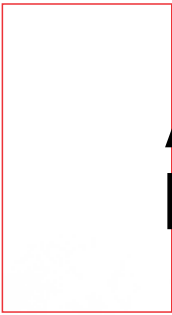
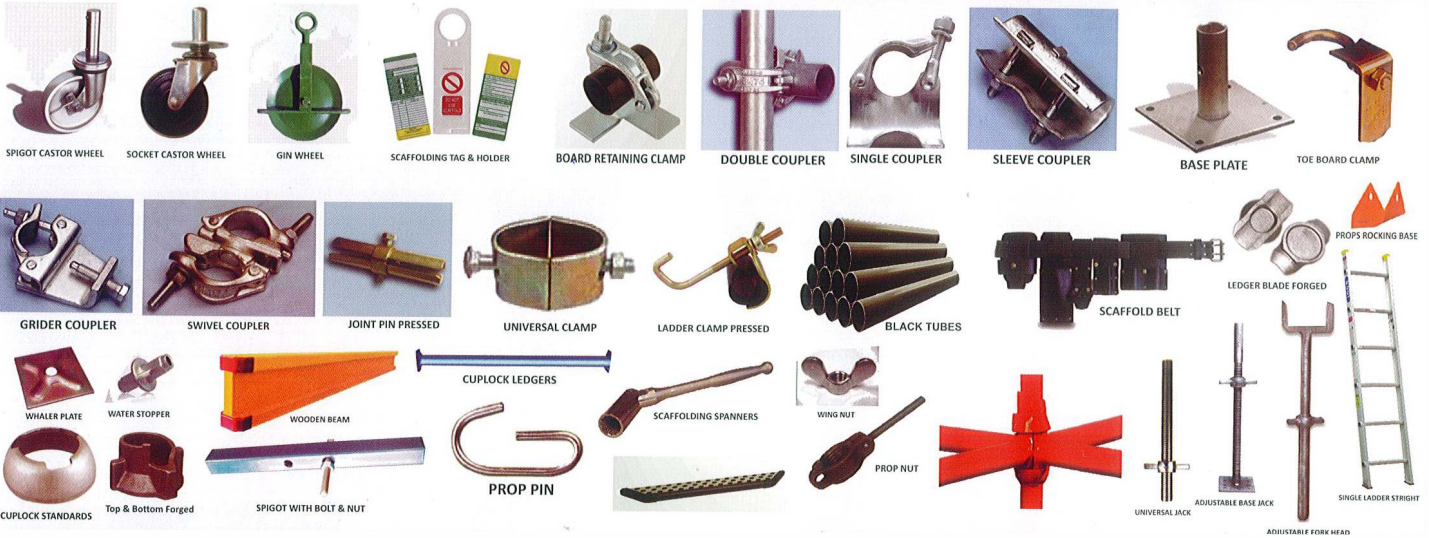

A Company of
Excellence.



Furniture :

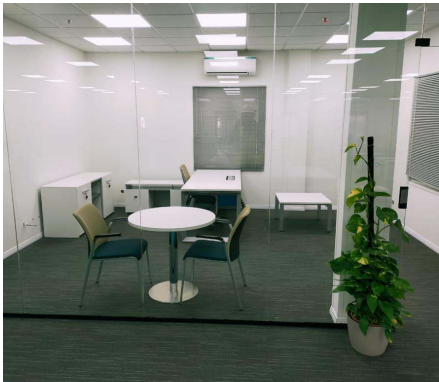

Recreational Items:



Miscellaneous Items



KEM 325U

KEM Polycarbonate 10-630A

- IP66; Enclosure types U2, U3, U4
- IP65; Enclosure types MF1 1, MF03, MF04
- Self-extinguishing material
- Wide operating temperature range
- Padlockable with 3 locks
- Door interlock with defeat mechanism
- Excellent insulating properties
- Good UV resistance
- Good resistance against many chemicals
- Tested according to IEC 60947-3
- **Note!** Al-cables cannot be connected directly to switch terminals. For Al-cable connection please use a bi-metal cable connector, **available here.**



KEM 16-40 A Installation guide video
>>

KEM 63-80 A Installation guide video
>>

Technical datasheet >>

Accessories

Data subject to change without notice. Always confirm the data is correct from the seller.



Product details

SKU	KEM 325U
AC-21 400/415 V (A)	40 A
AC-21 690 V (A)	40 A
AC-22 400/415 V (A)	25 A
AC-22 690 V (A)	25 A
AC-23 400/415 V (A/kW)	25 A / 11 kW
AC-23 690 V (A/kW)	25 A / 22 kW
Cable Area to Switch Terminal (mm²) / Bolt size	1.5-16
Color	Standard
EAN	6419410327685
Enclosure	U2
Enclosure Type	Polycarbonate
IP Rating	66
Number of Poles	3
Operation	Front-operated
Switch type	Load Break Switch
Weight (kg)	0.4

Dimensional drawing

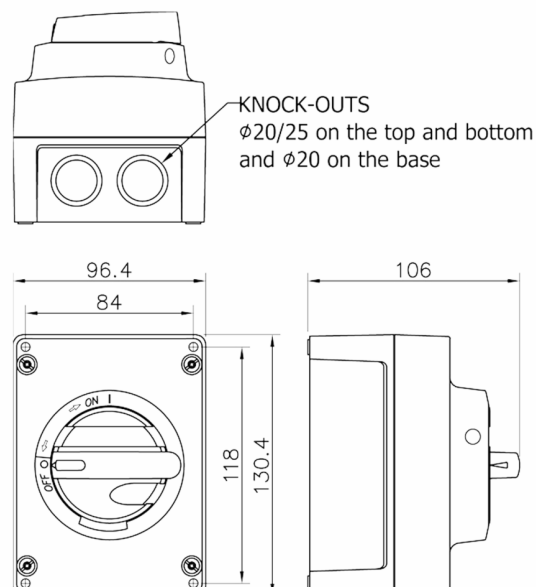



Al-Falah Jubail Trading. Est

**Get in
Touch**
with us



Post Box no.2758 Jubail-31951, Kingdom of Saudi Arabia

Tel : +966 58 159 9740 | +966 59 614 6976

Email : sales@alfalahksa.com

Website : www.alfalahksa.com